

NOTE:

- Demolition is shown on drawings - shts A2 through A5.
- Floor repairs are shown on drawings - shts A10 through A12
- Roof replacement is shown on drawings - sht A25
- Partition framing is shown on drawings - sht A9 through A12
- Elevator pit is shown on drawings - sht A9, A10 & A27
- Rough plumbing at floors is shown on - shts P2 through P5

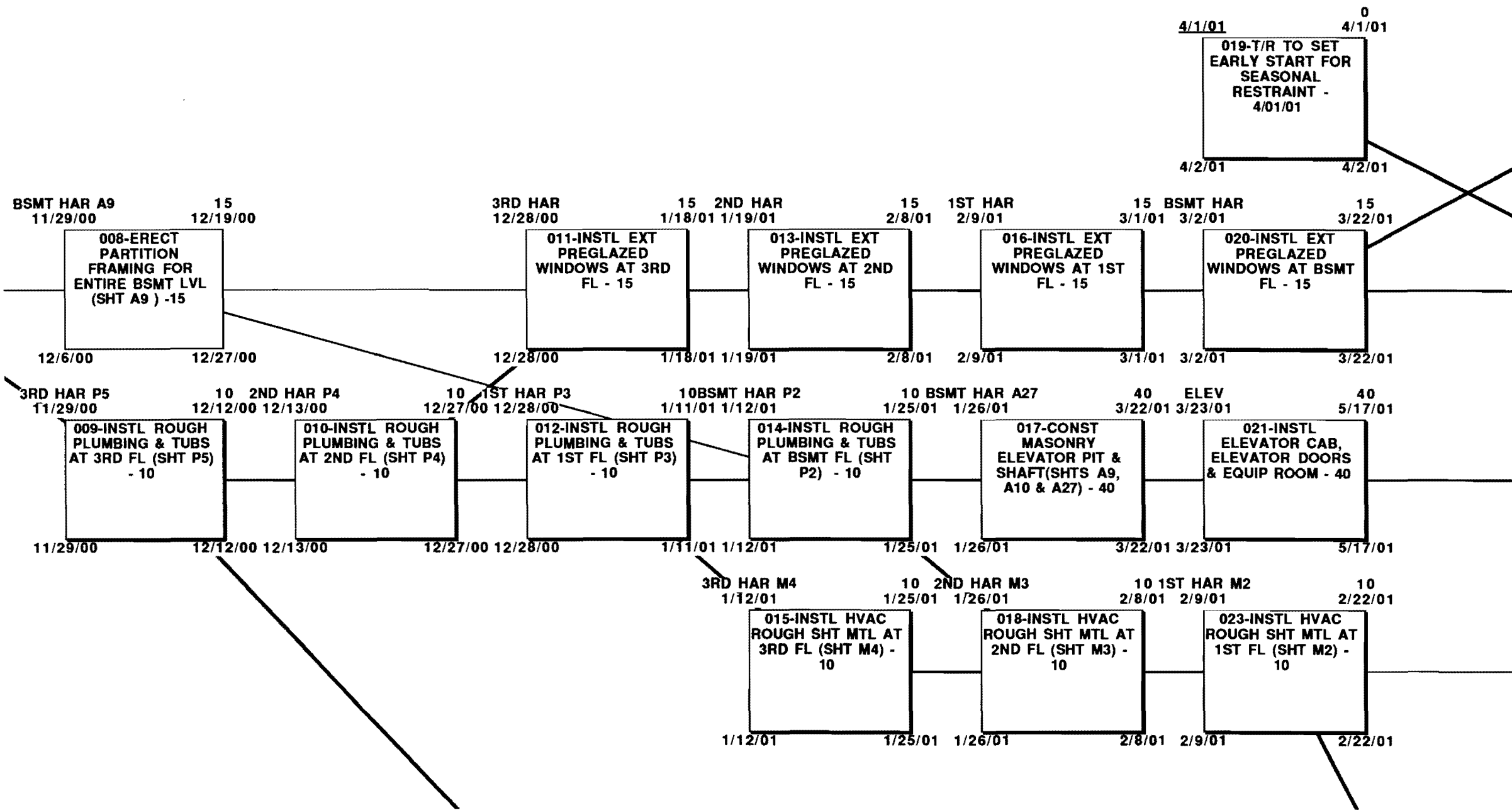

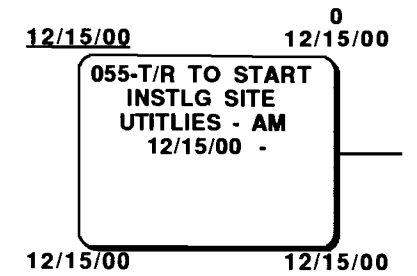

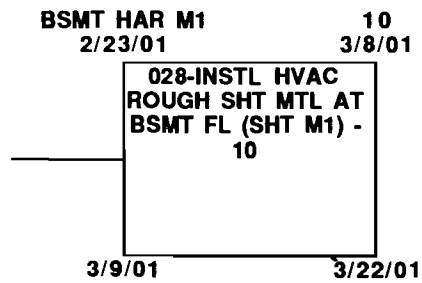
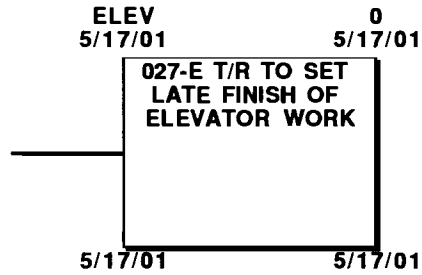
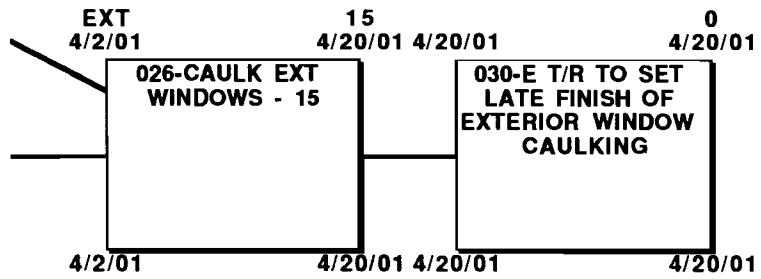
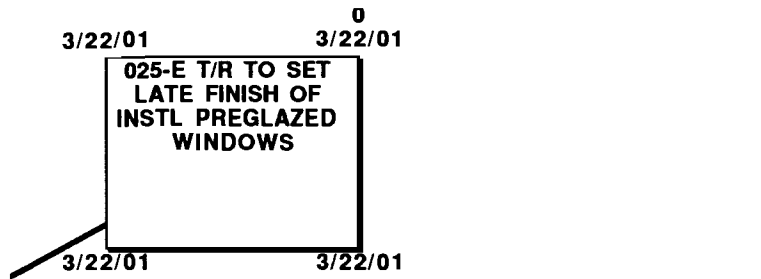
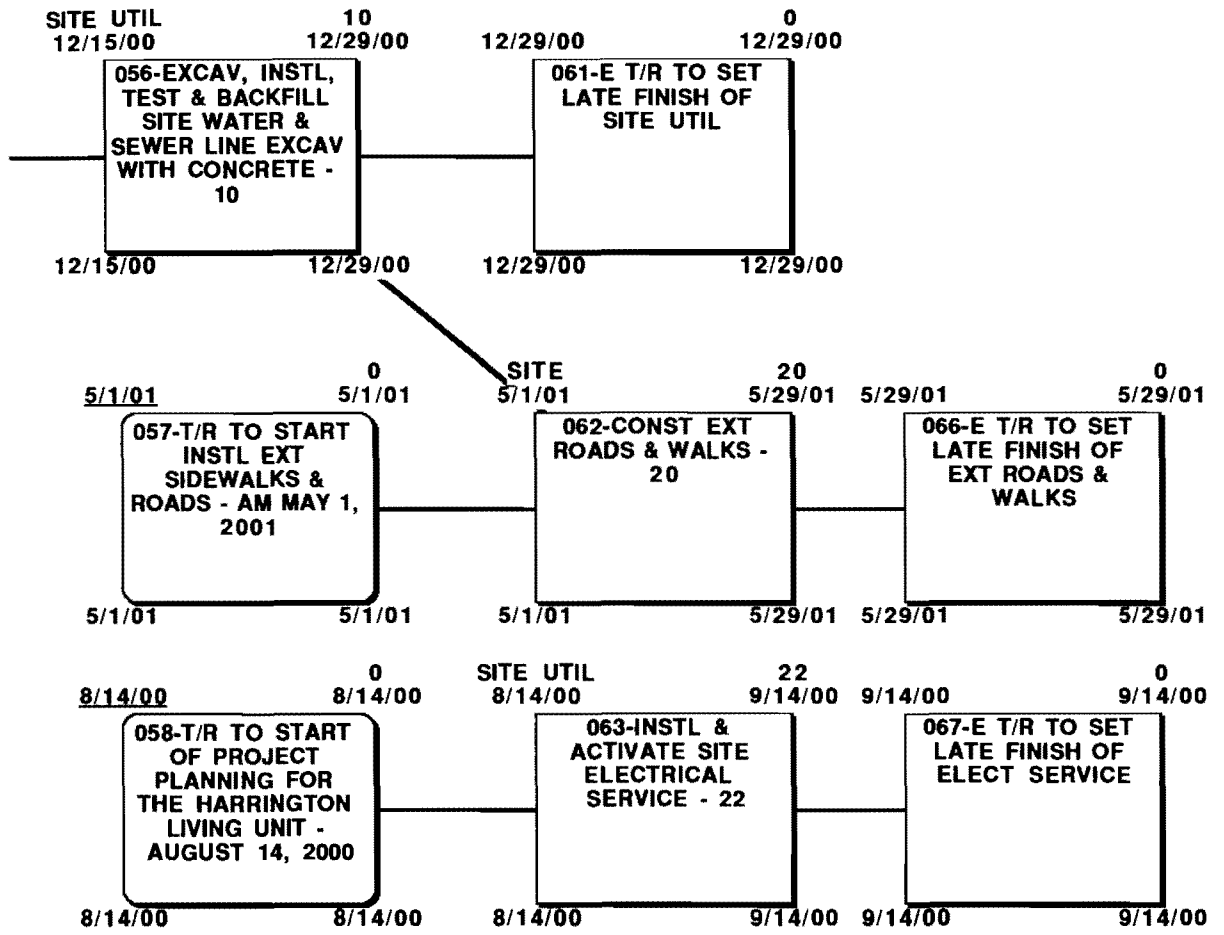

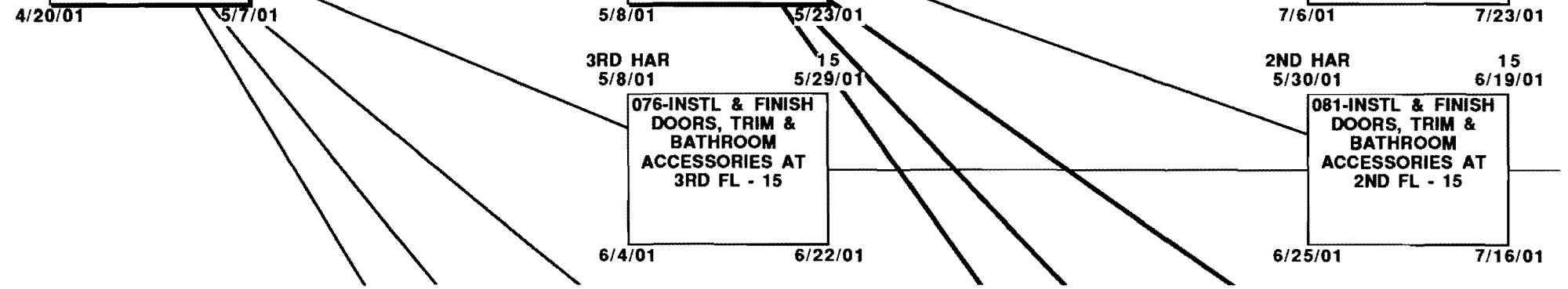
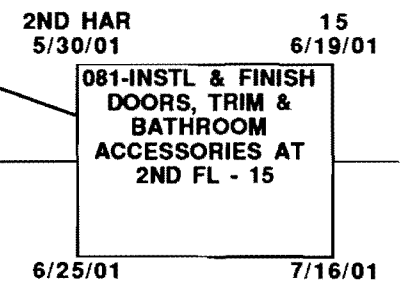
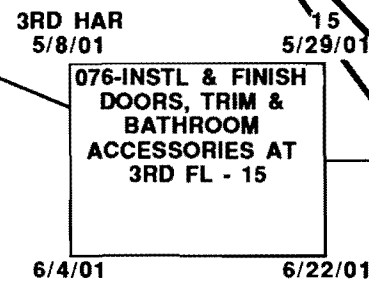
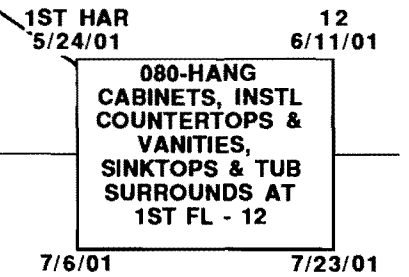
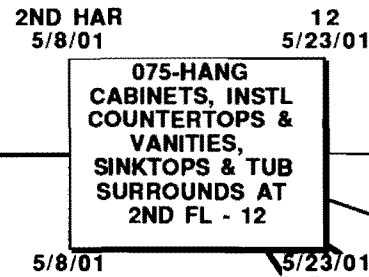
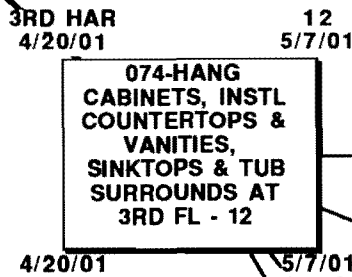
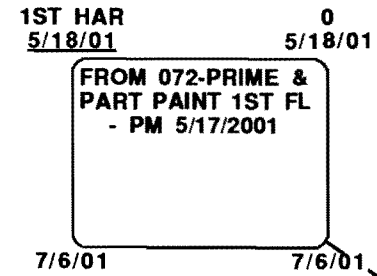
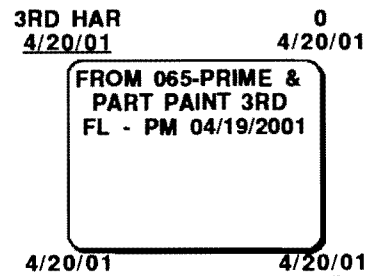

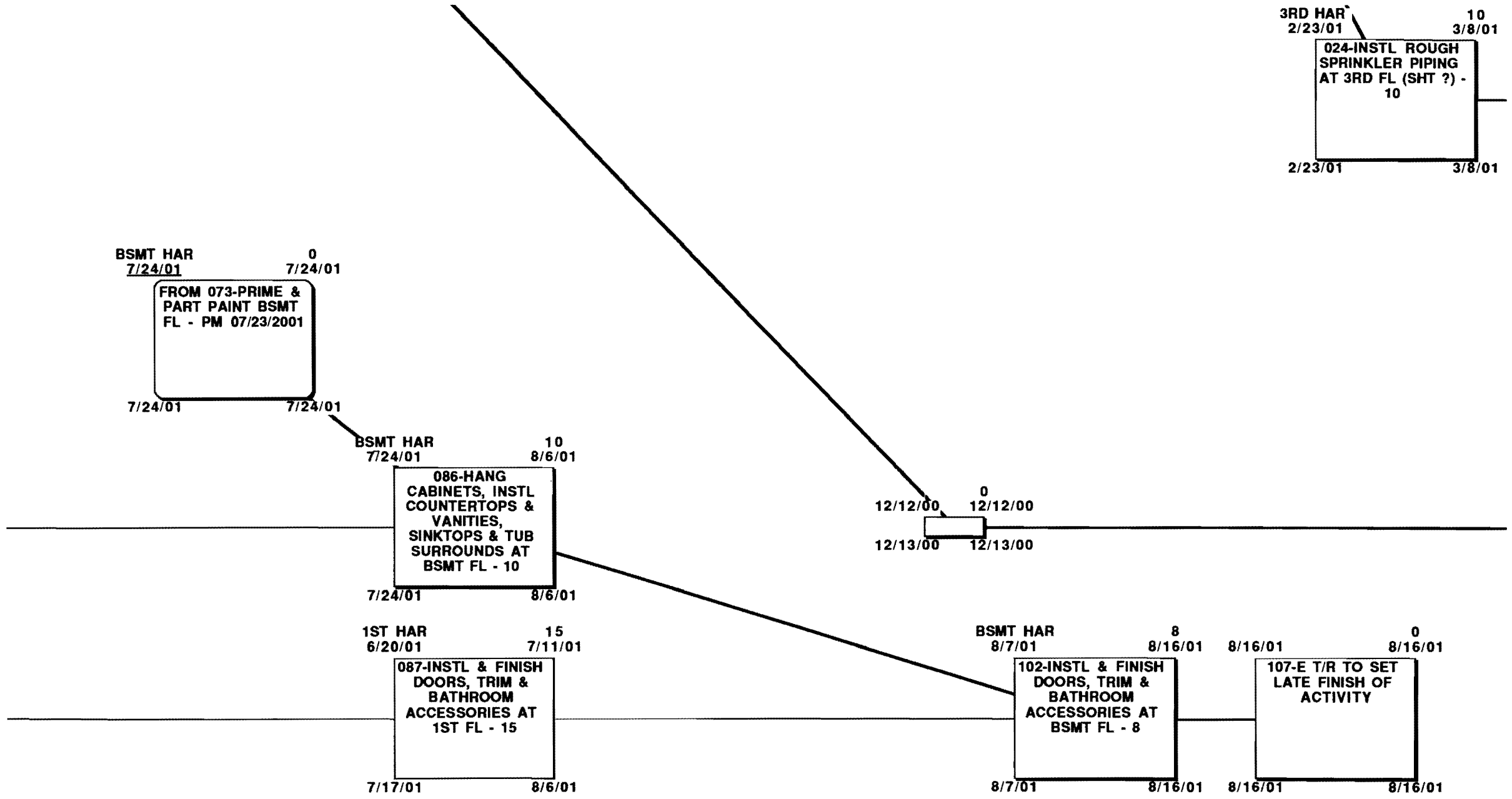
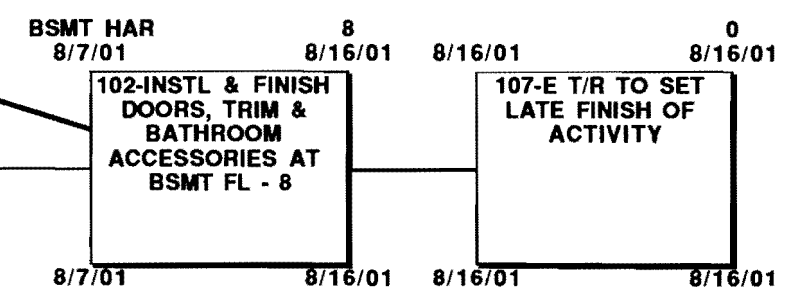
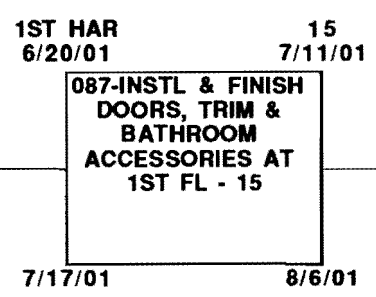
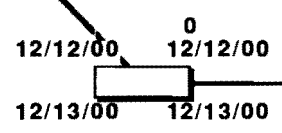
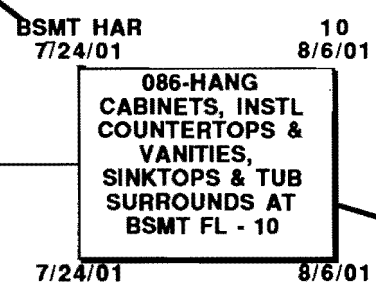
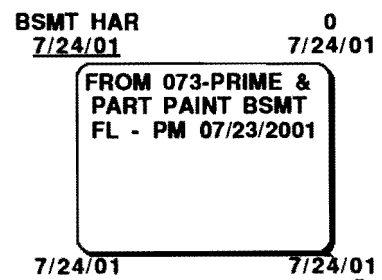
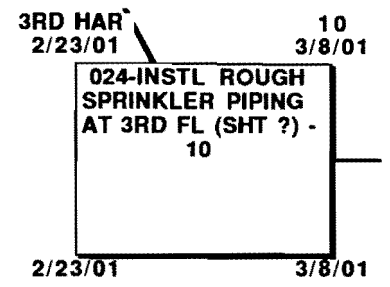

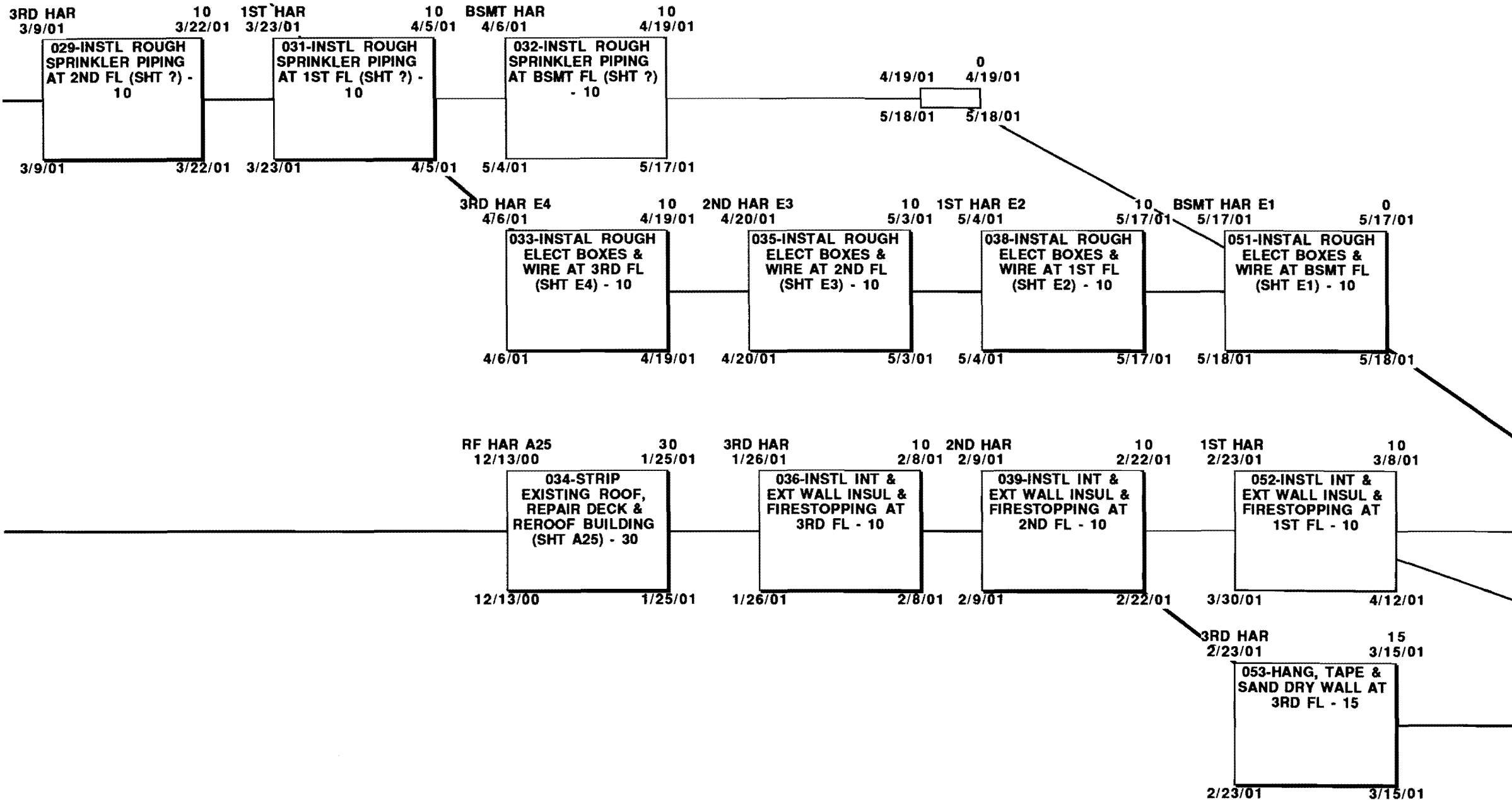

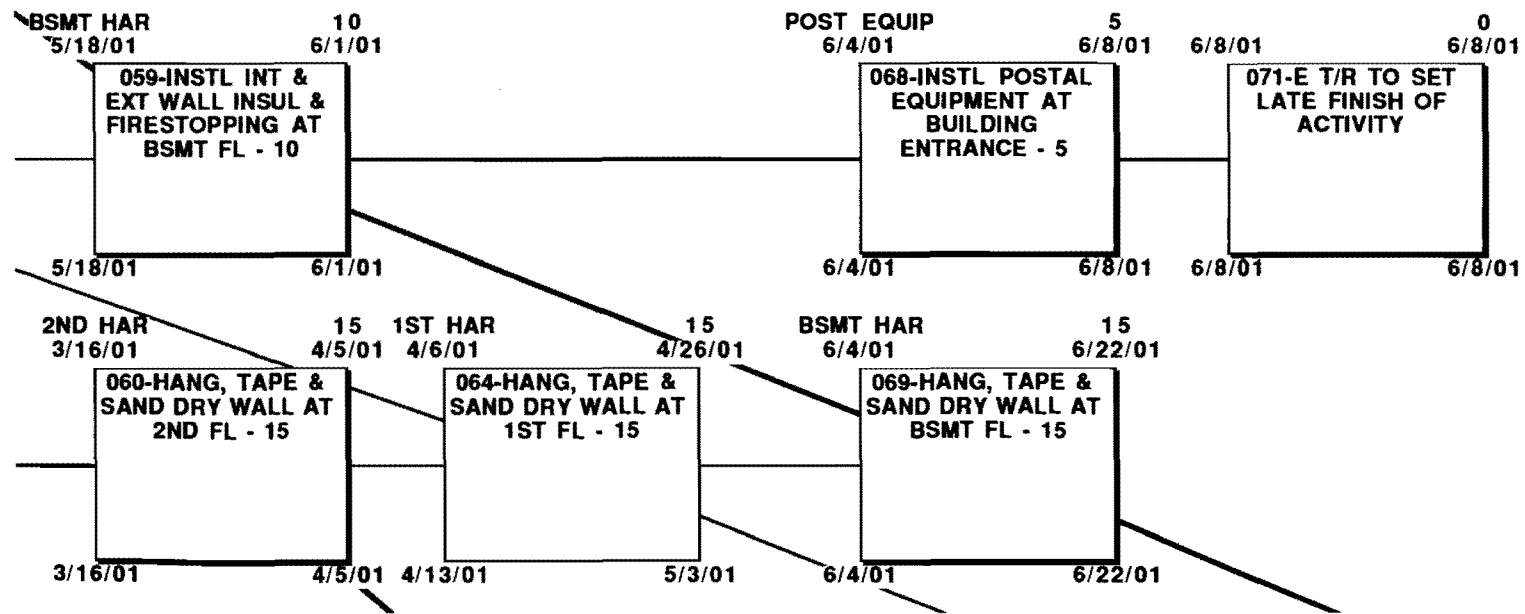

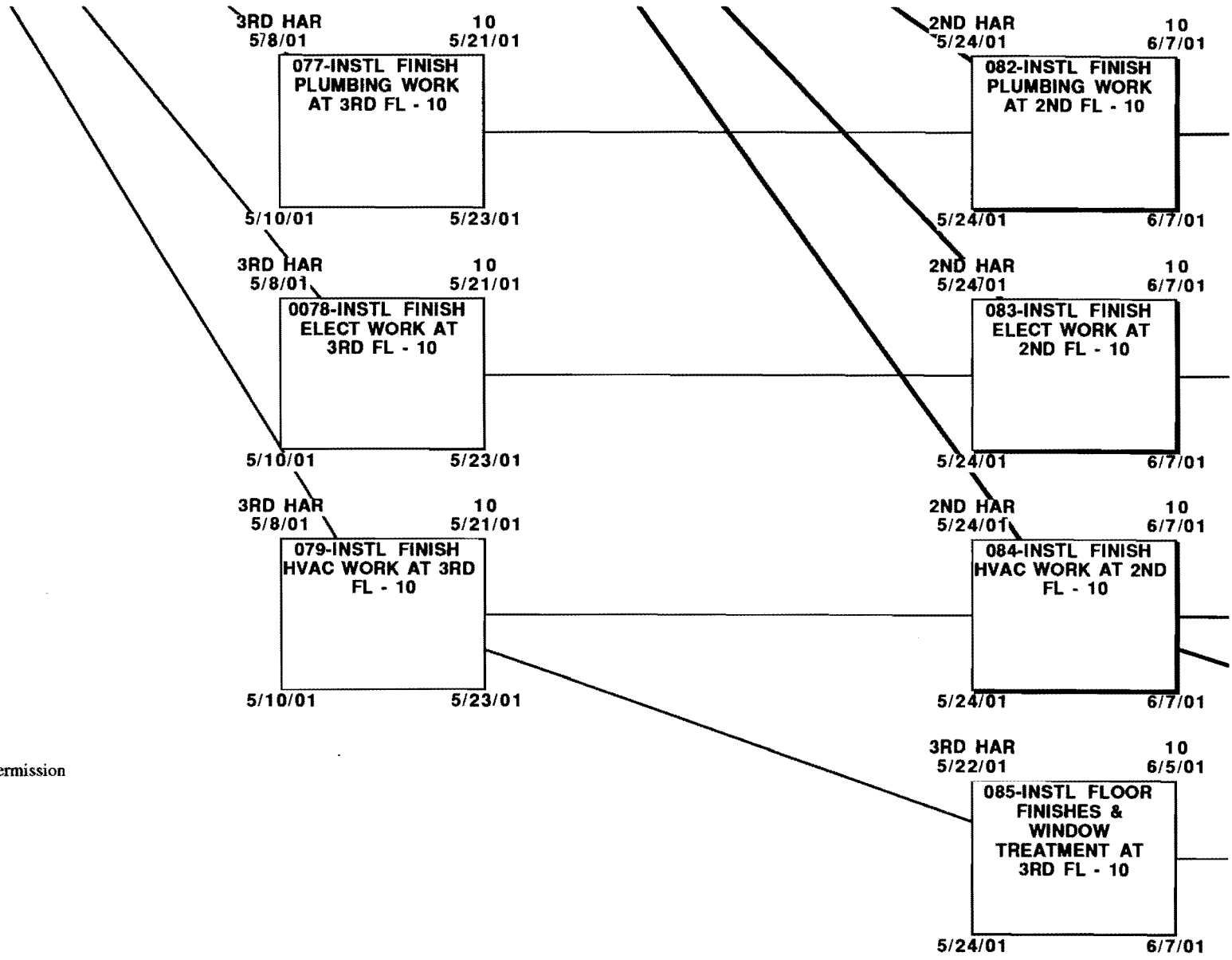

Note: Float time in this project is owned by Original Construction and use of float time by others on the project is to be only by written permission of the Original Construction project management staff.

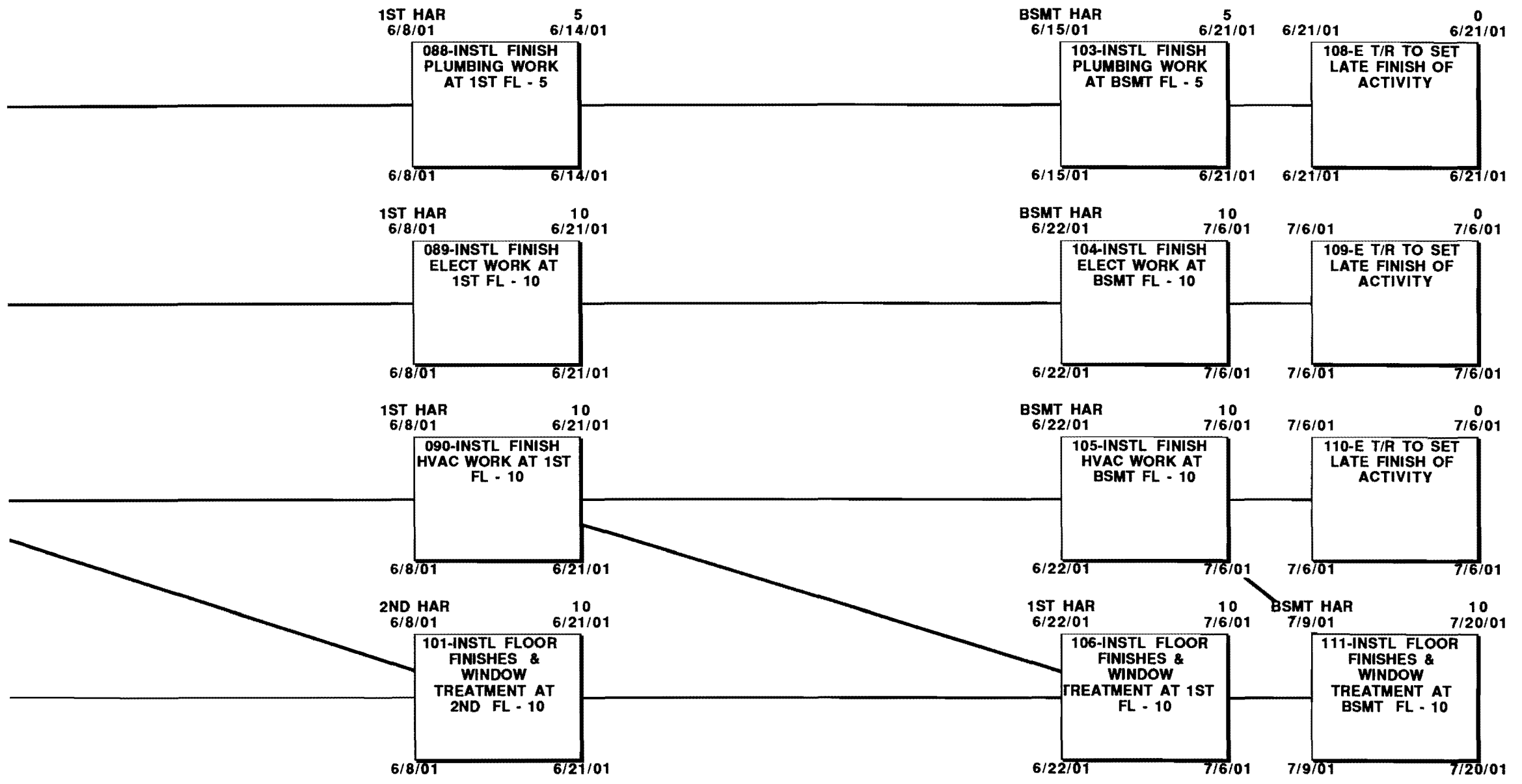

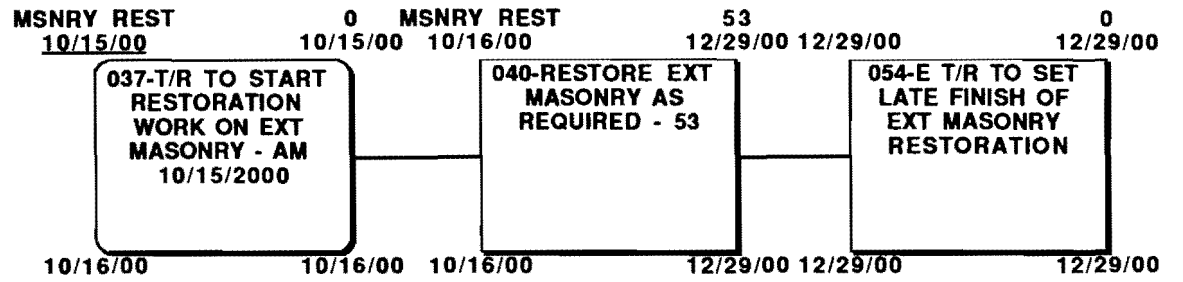

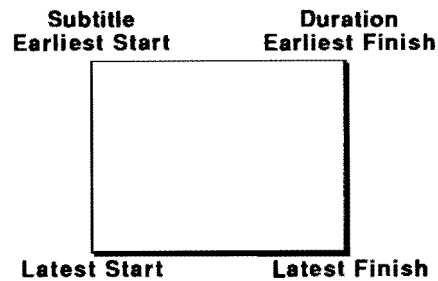
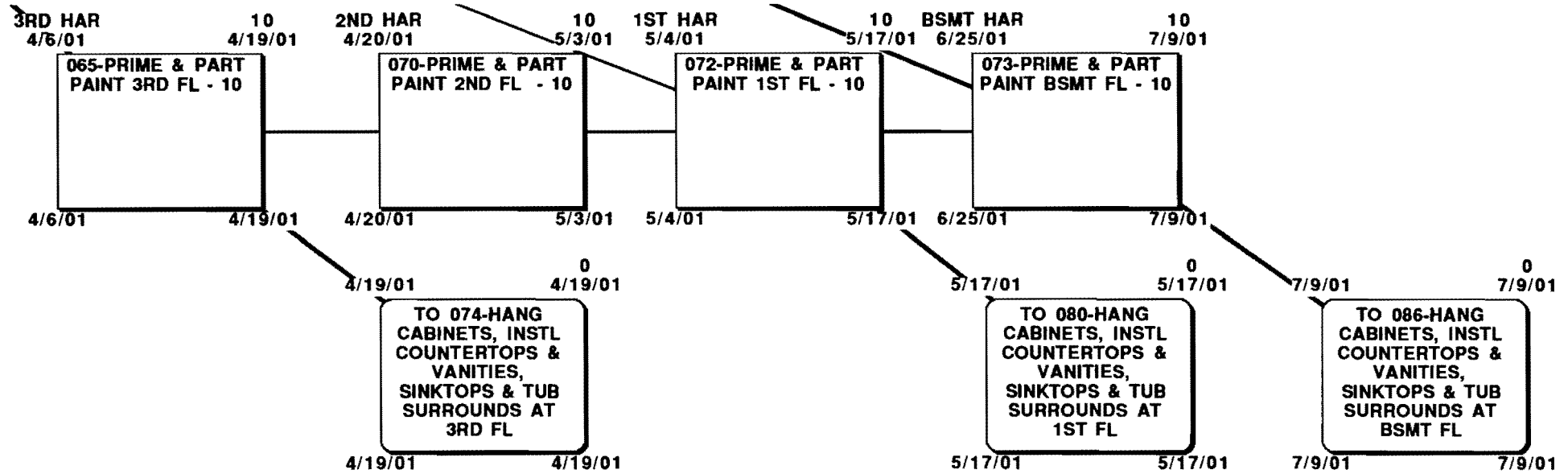

LEGEND KEY

Reserved Activity Numbers

041	046	091	096
042	047	092	097
043	048	093	098
044	049	094	099
045	050	095	100

lan 001
 han 111

Issue #4 - August 30, 2000

NETWORK MODEL FOR HARRINGTON RENOVATION PROGRAM - DETROIT, MI.

**Original Construction Co., Inc.
 General Contractors**

**16501 Wyoming Street
 Detroit, Michigan 48221**

Ralph J. Stephenson, P.E., P.C.
 Consultant
 323 Hiawatha Drive
 Mt. Pleasant, Michigan 48858
 ph 517 772 2537

**SHEET
 #1**

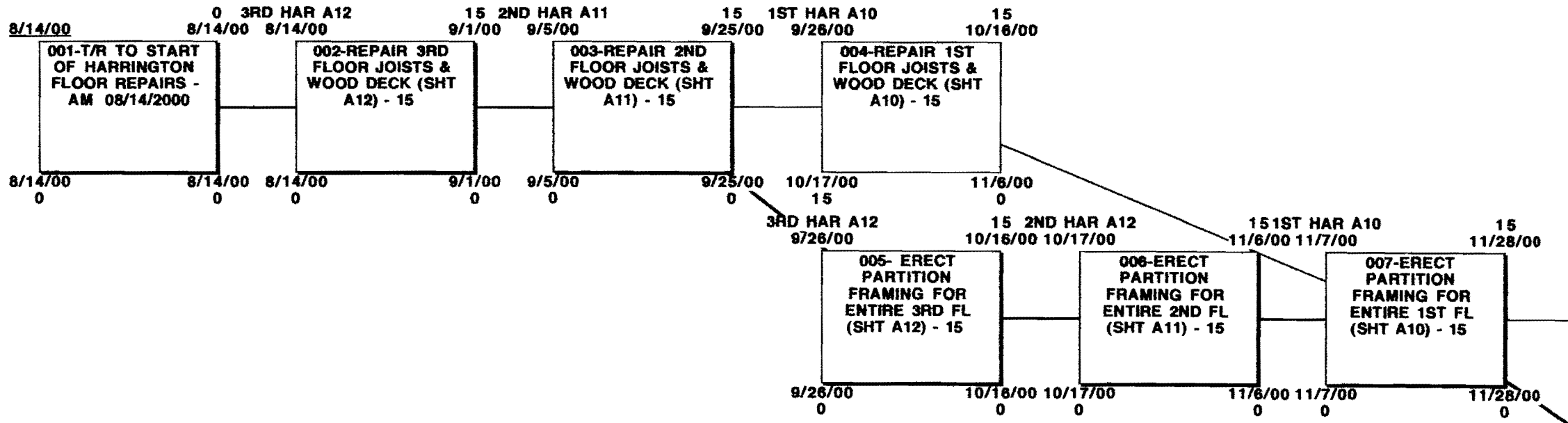

50:19

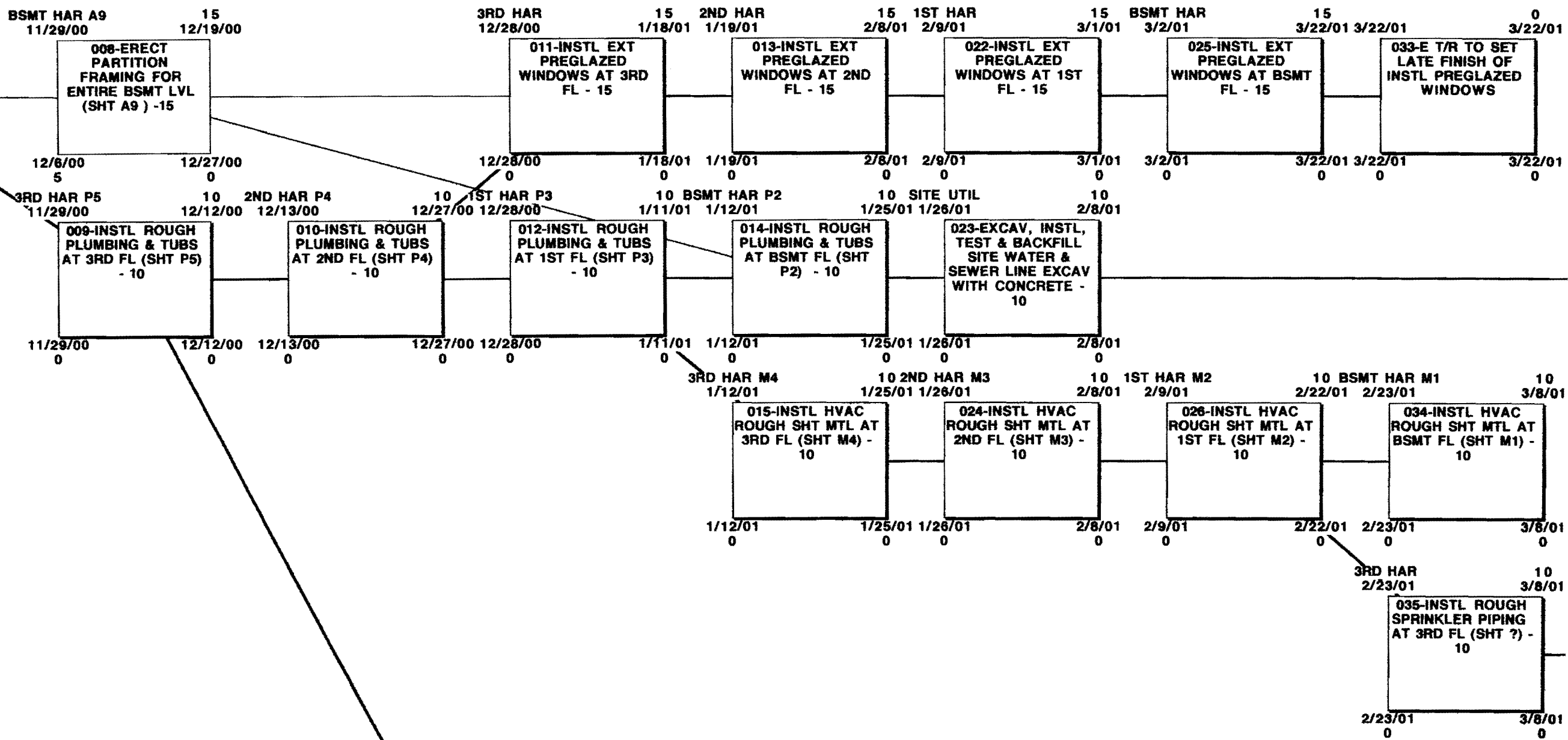

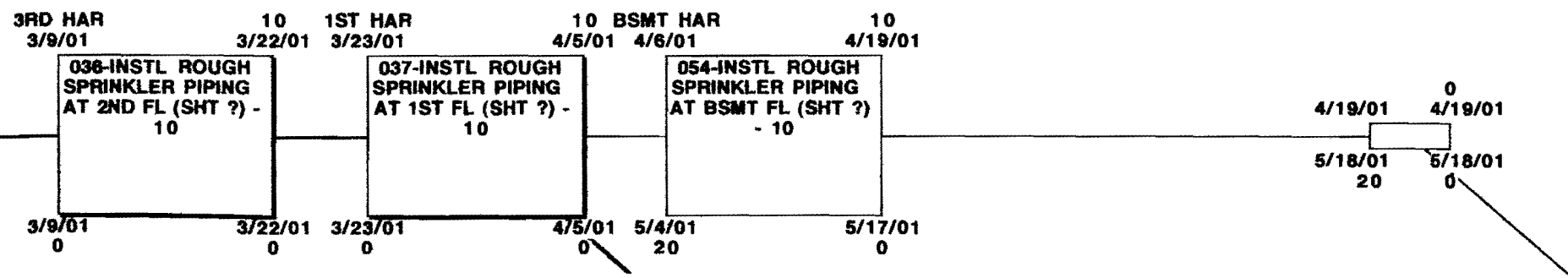
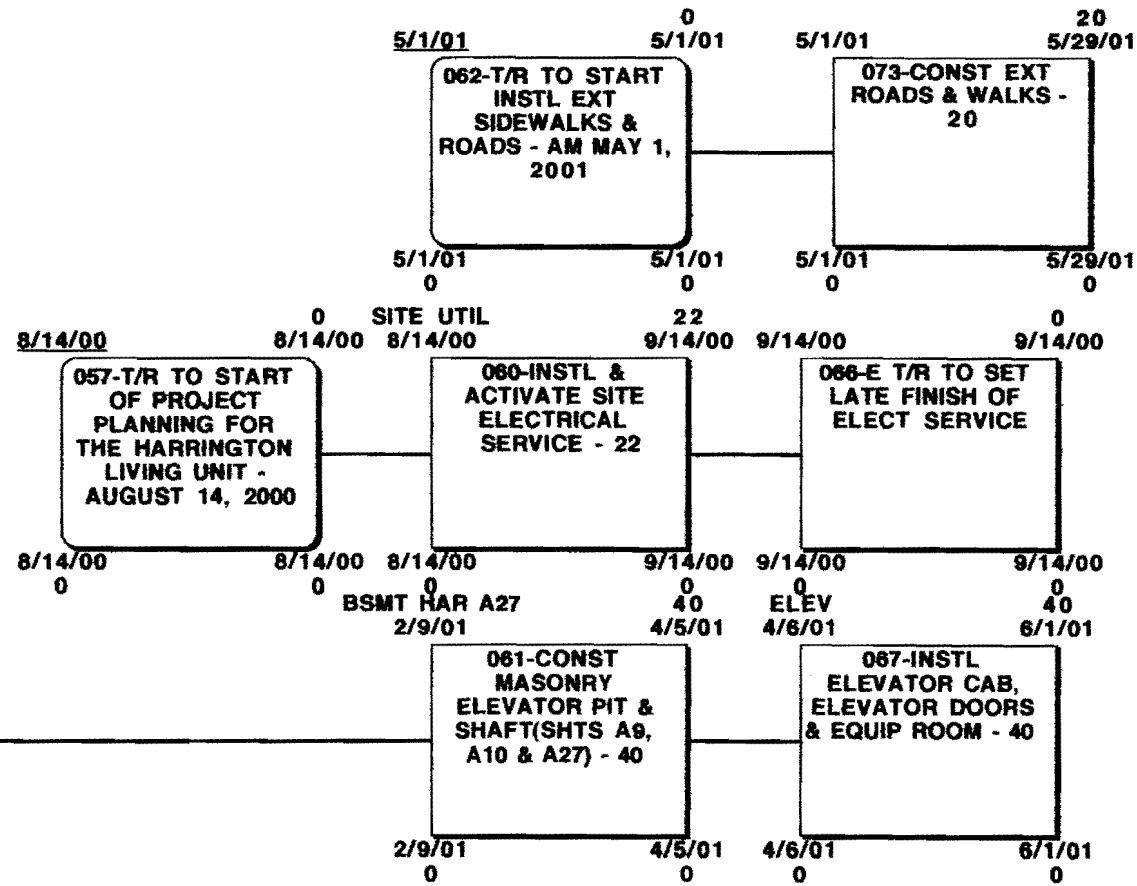

08/17/2000

PLAN #3 - LEAD TIMES ADJUSTED
TO WHAT THE TEAM FEELS
IS AN EFFECTIVE PERFORMANCE LEVEL

NOTE:

- **Demolition is shown on drawings - shts A2 through A5.**
- **Floor repairs are shown on drawings - shts A10 through A12**
- **Roof replacement is shown on drawings - sht A25**
- **Partition framing is shown on drawings - sht A9 through A12**
- **Elevator pit is shown on drawings - sht A9, A10 & A27**
- **Rough plumbing at floors is shown on - shts P2 through P5**

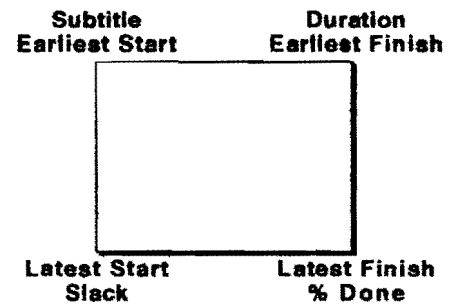

LEGEND KEY

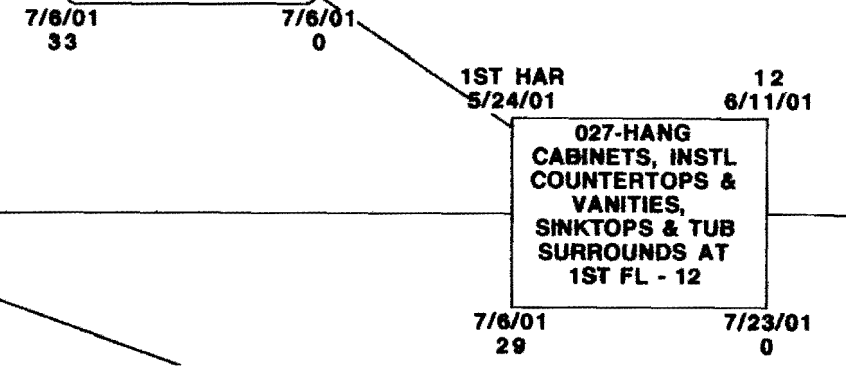
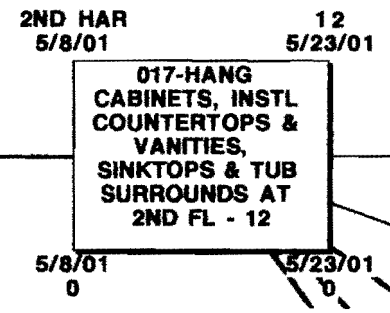
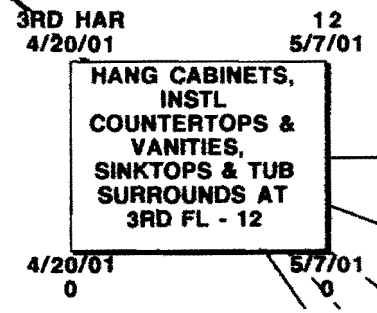
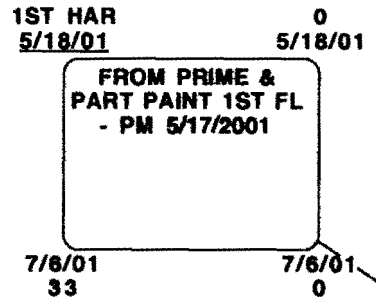
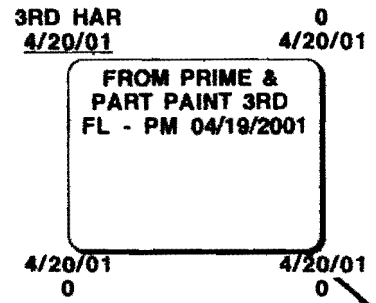
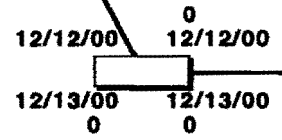

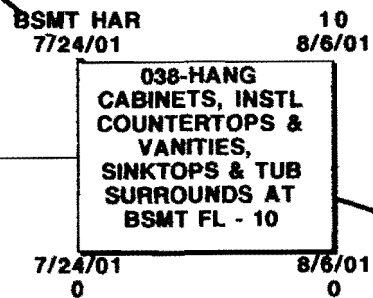
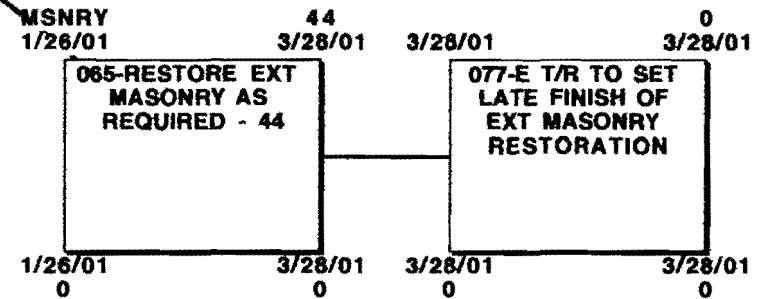
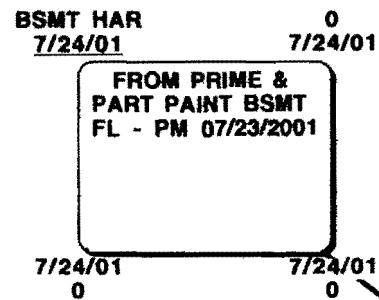
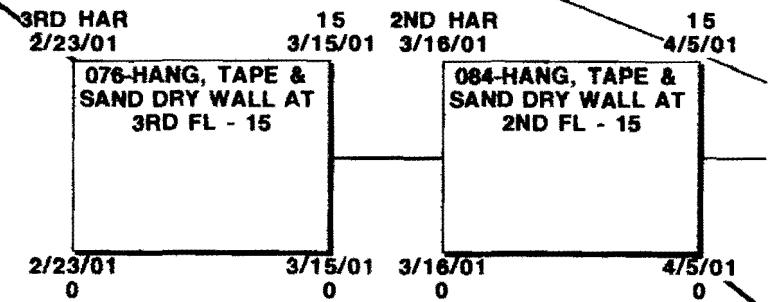
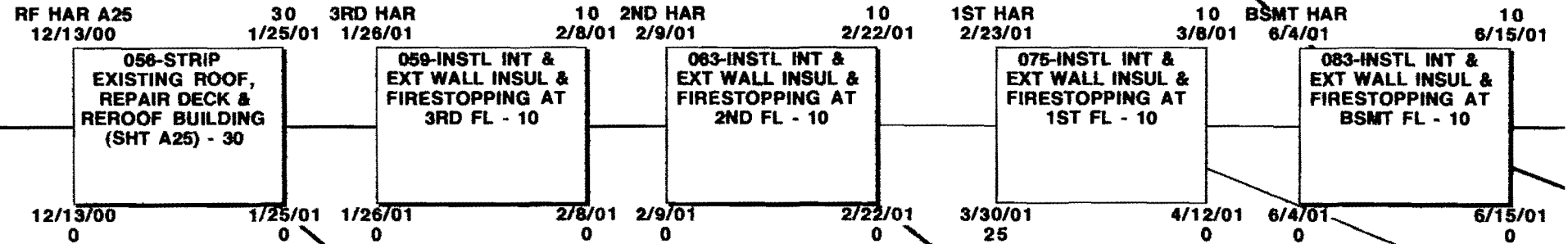
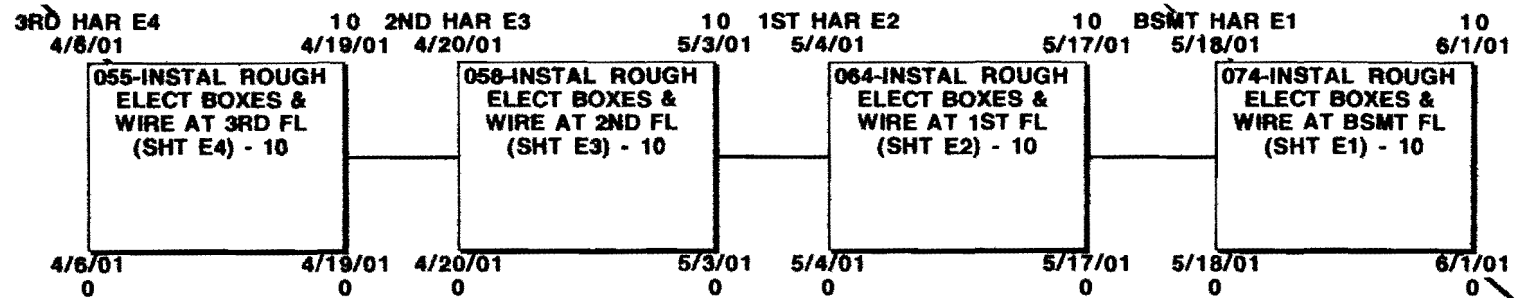

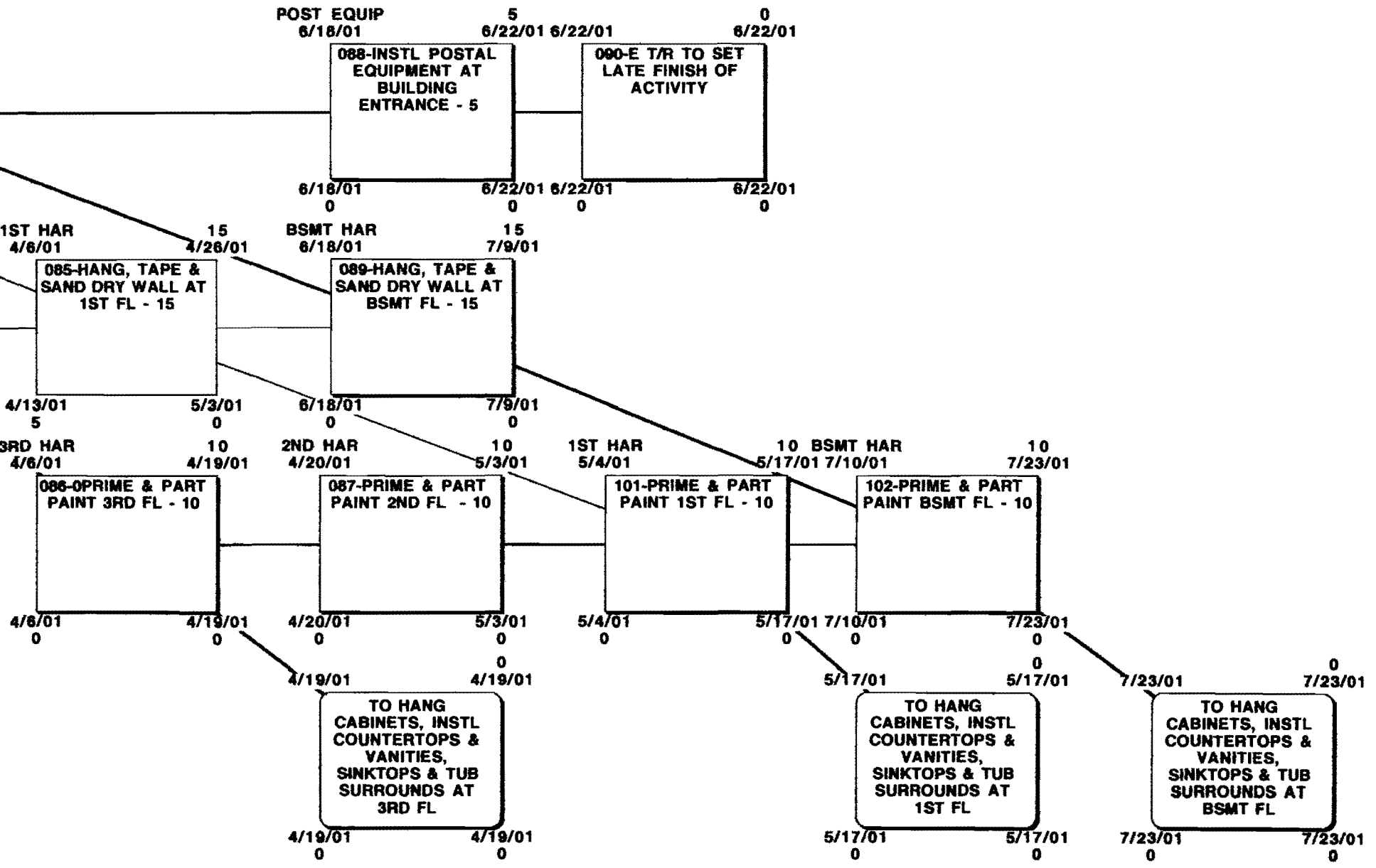

**Note: Float time in this project is owned by Original Construction
and use of float time by others on the project is to be only by written permission
of the Original Construction project management staff.**

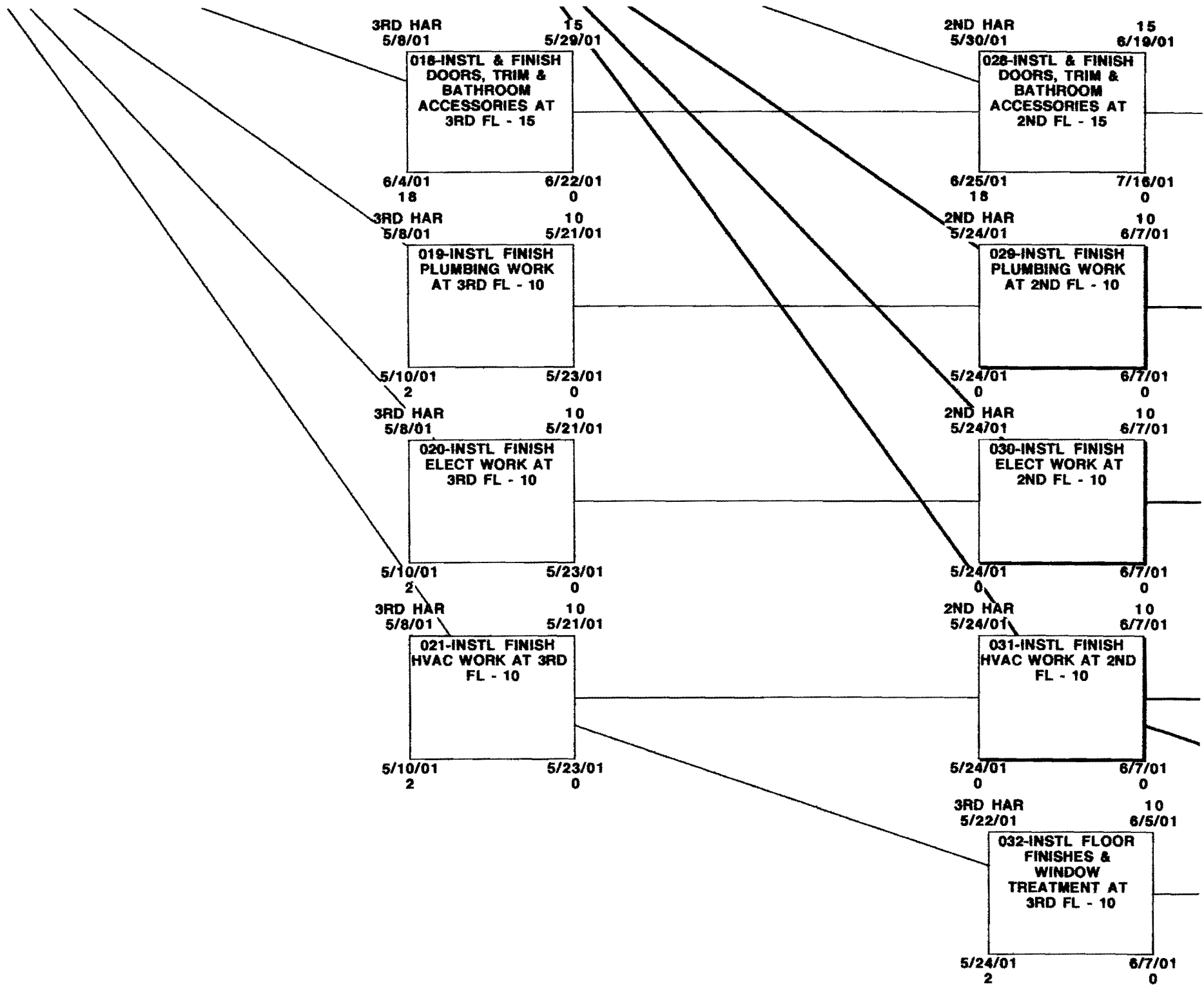

3RD HAR 5/8/01 15 5/29/01

2ND HAR 5/30/01 15 6/19/01

018-INSTL & FINISH DOORS, TRIM & BATHROOM ACCESSORIES AT 3RD FL - 15

028-INSTL & FINISH DOORS, TRIM & BATHROOM ACCESSORIES AT 2ND FL - 15

6/4/01 6/22/01
18 0

6/25/01 7/16/01
18 0

3RD HAR 5/8/01 10 5/21/01

2ND HAR 5/24/01 10 6/7/01

019-INSTL FINISH PLUMBING WORK AT 3RD FL - 10

029-INSTL FINISH PLUMBING WORK AT 2ND FL - 10

5/10/01 5/23/01
2 0

5/24/01 6/7/01
0 0

3RD HAR 5/8/01 10 5/21/01

2ND HAR 5/24/01 10 6/7/01

020-INSTL FINISH ELECT WORK AT 3RD FL - 10

030-INSTL FINISH ELECT WORK AT 2ND FL - 10

5/10/01 5/23/01
2 0

5/24/01 6/7/01
0 0

3RD HAR 5/8/01 10 5/21/01

2ND HAR 5/24/01 10 6/7/01

021-INSTL FINISH HVAC WORK AT 3RD FL - 10

031-INSTL FINISH HVAC WORK AT 2ND FL - 10

5/10/01 5/23/01
2 0

5/24/01 6/7/01
0 0

3RD HAR 5/22/01 10 6/5/01

032-INSTL FLOOR FINISHES & WINDOW TREATMENT AT 3RD FL - 10

5/24/01 6/7/01
2 0

1ST HAR 15
6/20/01 7/11/01

039-INSTL & FINISH
DOORS, TRIM &
BATHROOM
ACCESSORIES AT
1ST FL - 15

7/17/01 8/6/01
18 0

1ST HAR 5
6/8/01 6/14/01

040-INSTL FINISH
PLUMBING WORK
AT 1ST FL - 5

6/8/01 6/14/01
0 0

1ST HAR 10
6/8/01 6/21/01

051-INSTL FINISH
ELECT WORK AT
1ST FL - 10

6/8/01 6/21/01
0 0

1ST HAR 10
6/8/01 6/21/01

052-INSTL FINISH
HVAC WORK AT 1ST
FL - 10

6/8/01 6/21/01
0 0

2ND HAR 10
6/8/01 6/21/01

053-INSTL FLOOR
FINISHES &
WINDOW
TREATMENT AT
2ND FL - 10

6/8/01 6/21/01
0 0

BSMT HAR 8 0
8/7/01 8/16/01 8/16/01 8/16/01

068-INSTL & FINISH
DOORS, TRIM &
BATHROOM
ACCESSORIES AT
BSMT FL - 8

8/7/01 8/16/01 8/16/01 8/16/01
0 0 0 0

BSMT HAR 5 0
6/15/01 6/21/01 6/21/01 6/21/01

069-INSTL FINISH
PLUMBING WORK
AT BSMT FL - 5

6/15/01 6/21/01 6/21/01 6/21/01
0 0 0 0

BSMT HAR 10 0
6/22/01 7/6/01 7/6/01 7/6/01

070-INSTL FINISH
ELECT WORK AT
BSMT FL - 10

6/22/01 7/6/01 7/6/01 7/6/01
0 0 0 0

BSMT HAR 10 0
6/22/01 7/6/01 7/6/01 7/6/01

071-INSTL FINISH
HVAC WORK AT
BSMT FL - 10

6/22/01 7/6/01 7/6/01 7/6/01
0 0 0 0

1ST HAR 10 BSMT HAR 10
6/22/01 7/6/01 7/9/01 7/20/01

072-INSTL FLOOR
FINISHES &
WINDOW
TREATMENT AT 1ST
FL - 10

6/22/01 7/6/01
0 0

078-E T/R TO SET
LATE FINISH OF
ACTIVITY

079-E T/R TO SET
LATE FINISH OF
ACTIVITY

080-E T/R TO SET
LATE FINISH OF
ACTIVITY

081-E T/R TO SET
LATE FINISH OF
ACTIVITY

082-INSTL FLOOR
FINISHES &
WINDOW
TREATMENT AT
BSMT FL - 10

7/9/01 7/20/01
0 0

Issue #3 - August 18, 2000

**NETWORK MODEL FOR HARRINGTON
RENOVATION PROGRAM**

Original Construction Co., Inc.